

OPTION HARNESS (DISPLAY AUDIO WITH BOSE SYSTEM)

RC : With rear view monitor

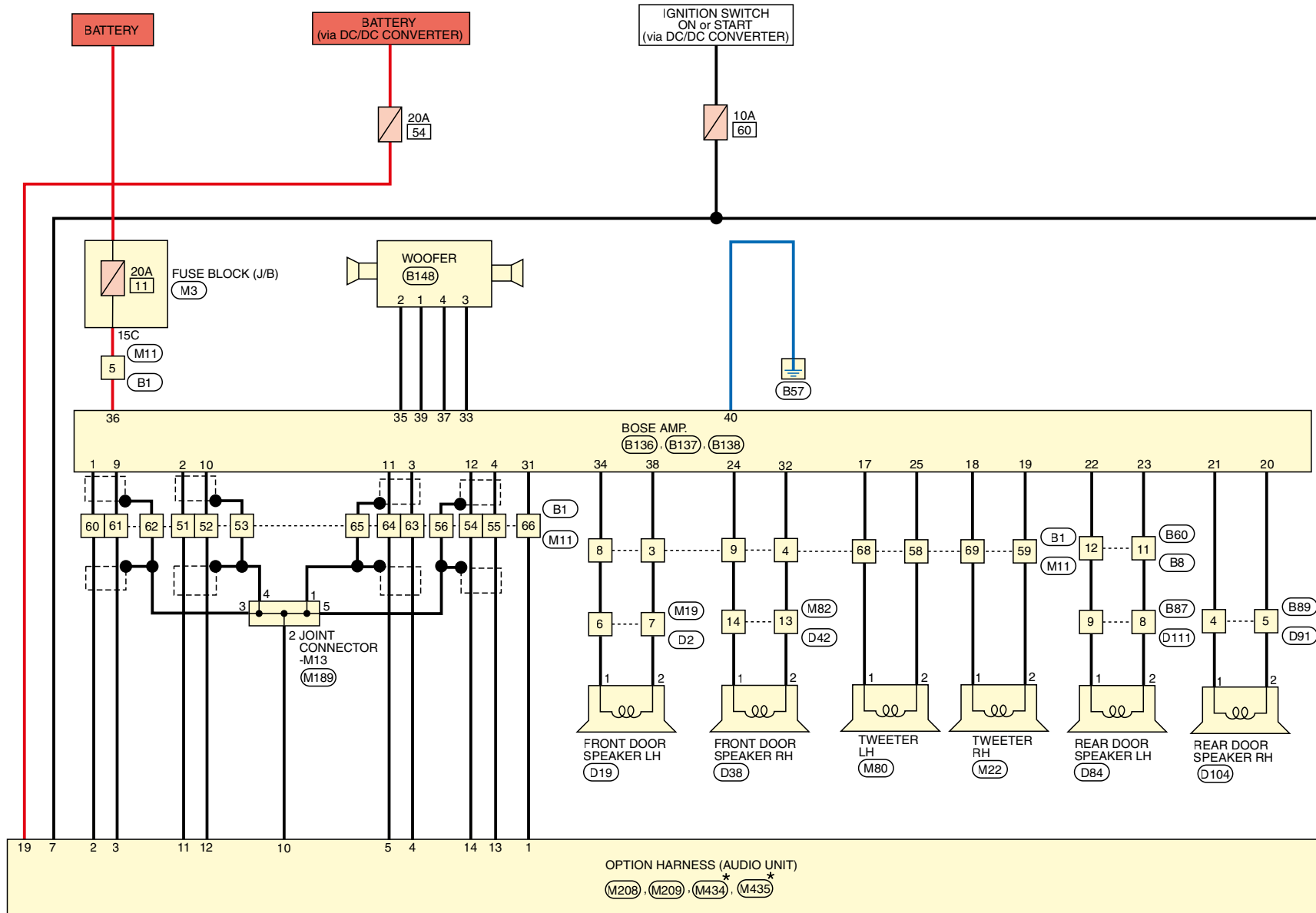

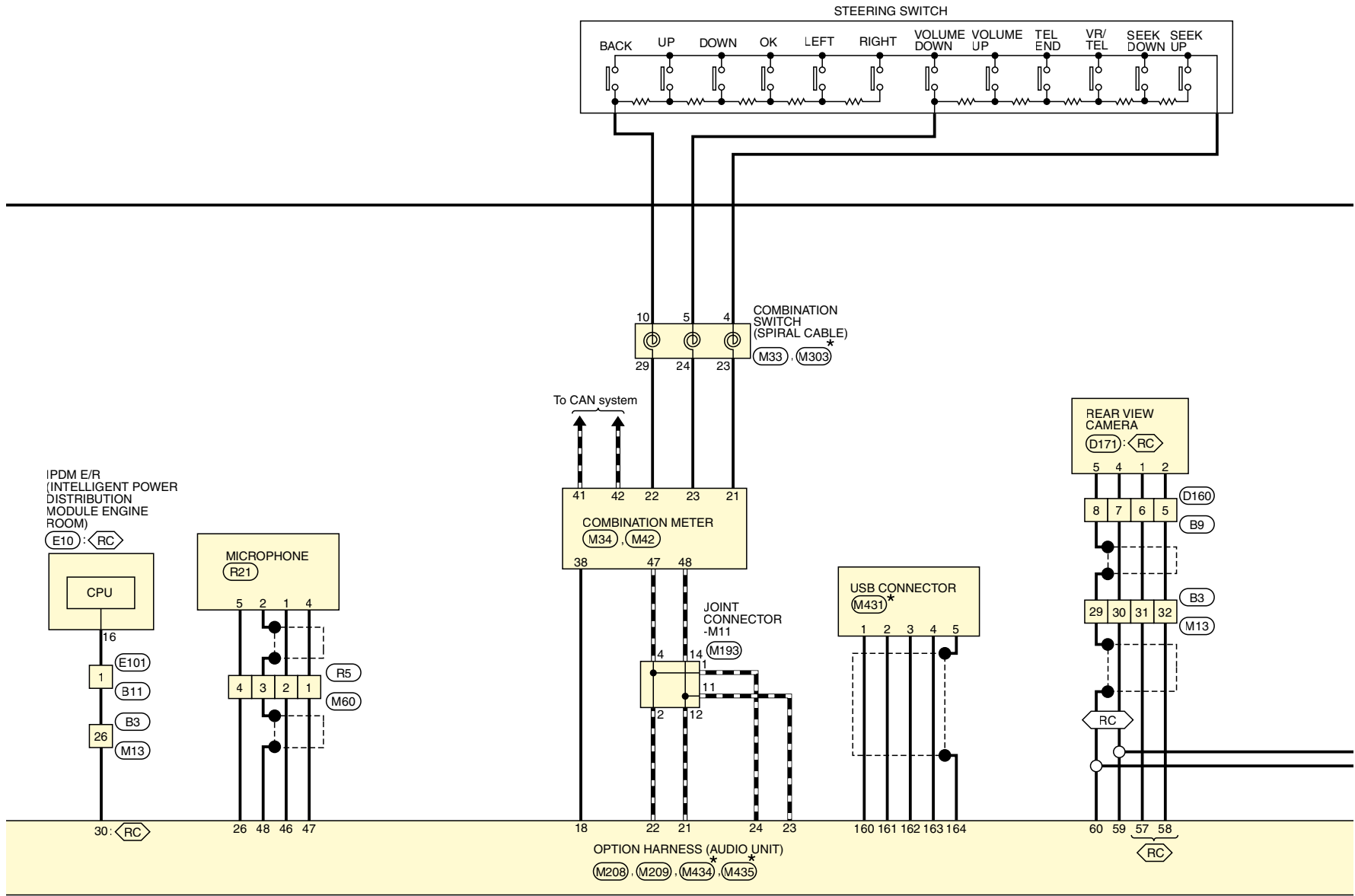

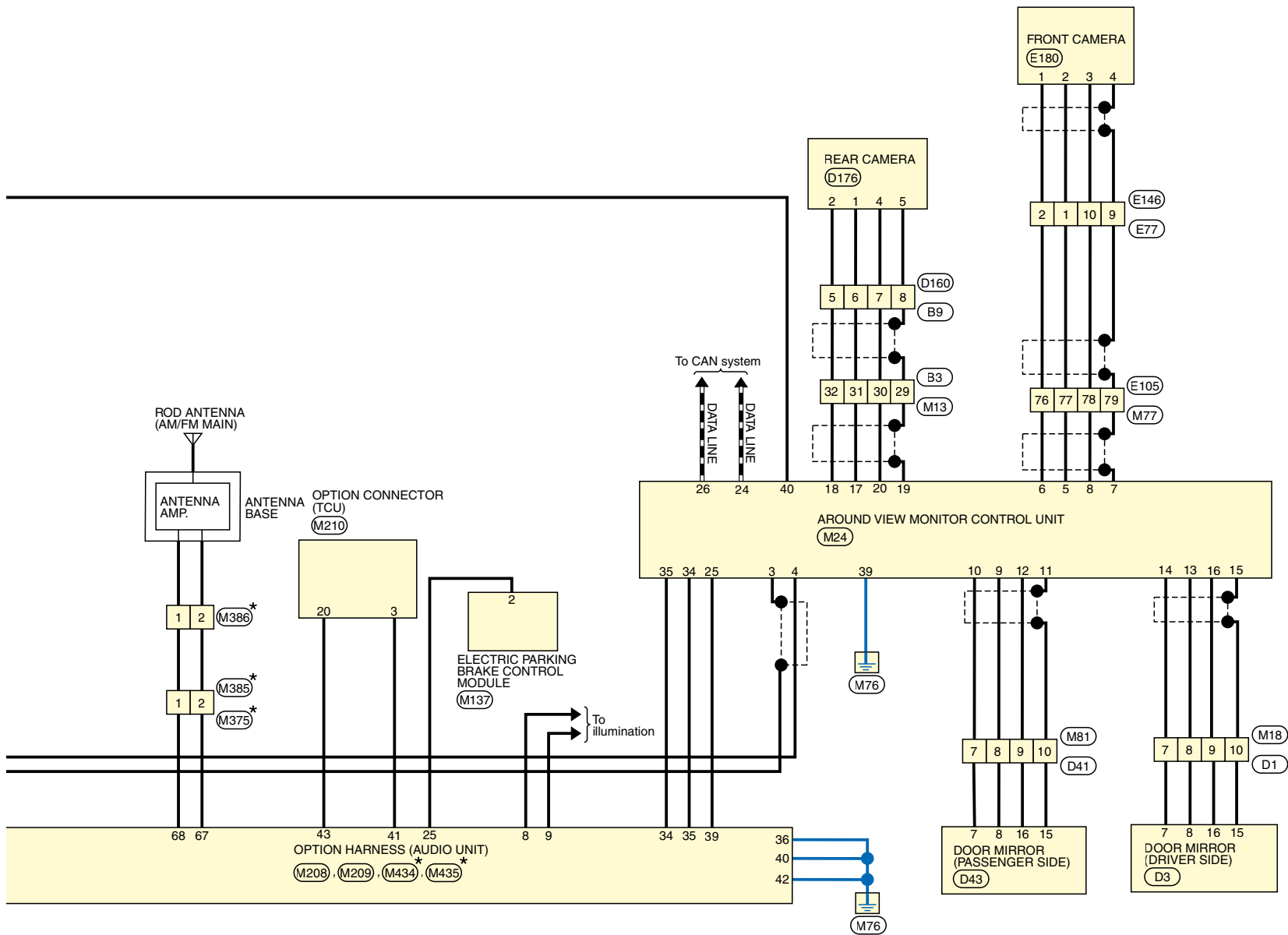

OPTION HARNESS (DISPLAY AUDIO WITH BOSE SYSTEM)

Connector No.	B1
Connector Name	WIRE TO WIRE
Connector Type	TH80MW-CS16-TM4
Connector Color	White

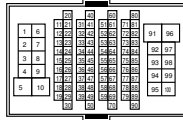

Terminal No.	Color Of Wire	Signal Name [Specification]
1	Y	TO MAIN HARNESS
2	LA/Y	TO MAIN HARNESS
3	P	TO MAIN HARNESS
4	R	TO MAIN HARNESS
5	L	TO MAIN HARNESS
6	V	TO MAIN HARNESS
7	LA/V	TO MAIN HARNESS
8	BR	TO MAIN HARNESS
9	G	TO MAIN HARNESS
22	LA/V	TO MAIN HARNESS
23	LA/R	TO MAIN HARNESS
31	BR	TO MAIN HARNESS
32	R	TO MAIN HARNESS
40	L	TO MAIN HARNESS
41	B	TO MAIN HARNESS
42	G	TO MAIN HARNESS
51	Y	TO MAIN HARNESS
52	L	TO MAIN HARNESS
53	SHIELD	TO MAIN HARNESS
54	R	TO MAIN HARNESS
55	W	TO MAIN HARNESS
56	SHIELD	TO MAIN HARNESS
58	GR	TO MAIN HARNESS
59	R	TO MAIN HARNESS
60	R	TO MAIN HARNESS
61	G	TO MAIN HARNESS
62	SHIELD	TO MAIN HARNESS
63	V	TO MAIN HARNESS
64	LG	TO MAIN HARNESS
65	SHIELD	TO MAIN HARNESS
66	BR	TO MAIN HARNESS
68	W	TO MAIN HARNESS
69	G	TO MAIN HARNESS
71	Y	TO MAIN HARNESS

72	Y	TO MAIN HARNESS
73	R	TO MAIN HARNESS [Without Forward Emergency Braking]
73	Y	TO MAIN HARNESS [With Forward Emergency Braking]
74	R	TO MAIN HARNESS
75	Y	TO MAIN HARNESS
76	BR	TO MAIN HARNESS
77	BR	TO MAIN HARNESS
78	LA/L	TO MAIN HARNESS
80	BR	TO MAIN HARNESS
81	GR	TO MAIN HARNESS [With Forward Emergency Braking]
81	L	TO MAIN HARNESS [Without Forward Emergency Braking]
82	GR	TO MAIN HARNESS [With Forward Emergency Braking]
82	L	TO MAIN HARNESS [Without Forward Emergency Braking]
83	L	TO MAIN HARNESS
84	L	TO MAIN HARNESS
85	GR	TO MAIN HARNESS
86	W	TO MAIN HARNESS
88	LA/B	TO MAIN HARNESS
90	G	TO MAIN HARNESS
91	BR	TO MAIN HARNESS
92	LA/R	TO MAIN HARNESS
93	LA/L	TO MAIN HARNESS
95	LA/BR	TO MAIN HARNESS
96	LG	TO MAIN HARNESS
97	L	TO MAIN HARNESS
98	Y	TO MAIN HARNESS
99	LA/P	TO MAIN HARNESS
100	LA/GR	TO MAIN HARNESS

Connector No.	B3
Connector Name	WIRE TO WIRE
Connector Type	TH32MW-NH
Connector Color	White

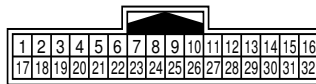

Terminal No.	Color Of Wire	Signal Name [Specification]
3	LA/R	TO MAIN HARNESS
4	V	TO MAIN HARNESS
5	GR	TO MAIN HARNESS
6	Y	TO MAIN HARNESS

7	LG	TO MAIN HARNESS
8	BG	TO MAIN HARNESS
9	BR	TO MAIN HARNESS
10	Y	TO MAIN HARNESS
11	R	TO MAIN HARNESS
17	LA/Y	TO MAIN HARNESS
18	LA/L	TO MAIN HARNESS
19	Y	TO MAIN HARNESS
20	L	TO MAIN HARNESS
24	P	TO MAIN HARNESS
25	L	TO MAIN HARNESS
26	G	TO MAIN HARNESS
29	SHIELD	TO MAIN HARNESS
30	W	TO MAIN HARNESS
31	B	TO MAIN HARNESS
32	R	TO MAIN HARNESS

Connector No.	B8
Connector Name	WIRE TO WIRE
Connector Type	NS16MW-CS
Connector Color	White

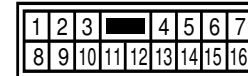

Terminal No.	Color Of Wire	Signal Name [Specification]
1	SB	TO BODY HARNESS
2	W	TO BODY HARNESS
3	LA/W	TO BODY HARNESS
6	LA/BR	TO BODY HARNESS
7	P	TO BODY HARNESS
8	L	TO BODY HARNESS
9	Y	TO BODY HARNESS
11	LA/G	TO BODY HARNESS
12	LA/P	TO BODY HARNESS
13	L	TO BODY HARNESS
14	Y	TO BODY HARNESS
15	G	TO BODY HARNESS
16	V	TO BODY HARNESS

Connector No.	B9
Connector Name	WIRE TO WIRE
Connector Type	TH32MW-NH
Connector Color	White

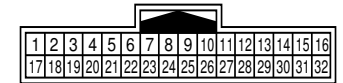

Terminal No.	Color Of Wire	Signal Name [Specification]
5	R	TO BODY HARNESS
6	B	TO BODY HARNESS
7	W	TO BODY HARNESS
8	SHIELD	TO BODY HARNESS
13	W	TO BODY HARNESS
14	V	TO BODY HARNESS
15	BR	TO BODY HARNESS
16	SB	TO BODY HARNESS
17	LA/W	TO BODY HARNESS
18	LA/BR	TO BODY HARNESS
19	LG	TO BODY HARNESS
21	G	TO BODY HARNESS
22	LA/R	TO BODY HARNESS
23	LA/R	TO BODY HARNESS
24	R	TO BODY HARNESS
29	Y	TO BODY HARNESS
30	G	TO BODY HARNESS
31	GR	TO BODY HARNESS
32	LG	TO BODY HARNESS

OPTION HARNESS (DISPLAY AUDIO WITH BOSE SYSTEM)

Connector No.	B11
Connector Name	WIRE TO WIRE
Connector Type	TH80MDGY-CS16-TM4
Connector Color	Dark Gray

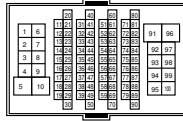

Terminal No.	Color Of Wire	Signal Name [Specification]
1	G	TO ENGINE ROOM HARNESS
2	LA/BR	TO ENGINE ROOM HARNESS
4	LG	TO ENGINE ROOM HARNESS
6	W	TO ENGINE ROOM HARNESS
8	BR	TO ENGINE ROOM HARNESS
11	SB	TO ENGINE ROOM HARNESS
12	V	TO ENGINE ROOM HARNESS
13	P	TO ENGINE ROOM HARNESS
14	W	TO ENGINE ROOM HARNESS
15	G	TO ENGINE ROOM HARNESS
16	LG	TO ENGINE ROOM HARNESS
17	Y	TO ENGINE ROOM HARNESS
20	R	TO ENGINE ROOM HARNESS
21	BR	TO ENGINE ROOM HARNESS
22	Y	TO ENGINE ROOM HARNESS
23	BG	TO ENGINE ROOM HARNESS
24	SB	TO ENGINE ROOM HARNESS
25	G	TO ENGINE ROOM HARNESS
26	B	TO ENGINE ROOM HARNESS
27	L	TO ENGINE ROOM HARNESS
100	SB	TO ENGINE ROOM HARNESS

Connector No.	B60
Connector Name	WIRE TO WIRE
Connector Type	NS16FW-CS
Connector Color	White

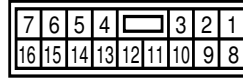

Terminal No.	Color Of Wire	Signal Name [Specification]
1	GR	TO BODY HARNESS
2	W	TO BODY HARNESS
3	LA/Y	TO BODY HARNESS
6	LA/BR	TO BODY HARNESS
7	LA/V	TO BODY HARNESS
8	L	TO BODY HARNESS
9	Y	TO BODY HARNESS
11	R	TO BODY HARNESS
12	L	TO BODY HARNESS
13	L	TO BODY HARNESS
14	Y	TO BODY HARNESS
15	LA/GR	TO BODY HARNESS
16	LA/LG	TO BODY HARNESS

Connector No.	B87
Connector Name	WIRE TO WIRE
Connector Type	NS12MW-CS
Connector Color	White

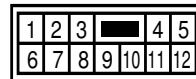

Terminal No.	Color Of Wire	Signal Name [Specification]
1	LA/P	TO DOOR HARNESS
2	LA/R	TO DOOR HARNESS
3	LA/V	TO DOOR HARNESS
6	W	TO DOOR HARNESS
7	L	TO DOOR HARNESS

8	LA/G	TO DOOR HARNESS [With 8-speakers]
8	LA/R	TO DOOR HARNESS [With 4-speakers or 6-speakers]
9	LA/L	TO DOOR HARNESS [With 4-speakers or 6-speakers]
9	LA/P	TO DOOR HARNESS [With 8-speakers]

Connector No.	B89
Connector Name	WIRE TO WIRE
Connector Type	NS12MW-CS
Connector Color	White

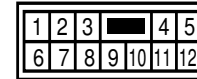

Terminal No.	Color Of Wire	Signal Name [Specification]
1	Y	TO DOOR HARNESS
2	L	TO DOOR HARNESS
3	LA/P	TO DOOR HARNESS
4	LA/V	TO DOOR HARNESS [With 4-speakers or 6-speakers]
4	LG	TO DOOR HARNESS [With 8-speakers]
5	LA/Y	TO DOOR HARNESS [With 4-speakers or 6-speakers]
5	V	TO DOOR HARNESS [With 8-speakers]
6	LA/GR	TO DOOR HARNESS
7	LA/LG	TO DOOR HARNESS

Connector No.	B136
Connector Name	BOSE AMP.
Connector Type	YAB16FB
Connector Color	Black

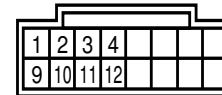

Terminal No.	Color Of Wire	Signal Name [Specification]
1	R	SOUND SIGNAL FRONT LH +
2	Y	SOUND SIGNAL FRONT RH +
3	V	SOUND SIGNAL REAR LH +

4	W	SOUND SIGNAL REAR RH +
9	G	SOUND SIGNAL FRONT LH -
10	L	SOUND SIGNAL FRONT RH -
11	LG	SOUND SIGNAL REAR LH -
12	R	SOUND SIGNAL REAR RH -

Connector No.	B137
Connector Name	BOSE AMP.
Connector Type	SEB16FB
Connector Color	Black

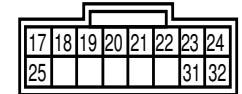

Terminal No.	Color Of Wire	Signal Name [Specification]
17	W	SOUND SIGNAL TWEETER LH +
18	G	SOUND SIGNAL TWEETER RH +
19	R	SOUND SIGNAL TWEETER RH -
20	V	SOUND SIGNAL REAR DOOR SPEAKER RH -
21	LG	SOUND SIGNAL REAR DOOR SPEAKER RH +
22	L	SOUND SIGNAL REAR DOOR SPEAKER LH +
23	R	SOUND SIGNAL REAR DOOR SPEAKER LH -
24	G	SOUND SIGNAL FRONT DOOR SPEAKER RH +
25	GR	SOUND SIGNAL TWEETER LH -
31	BR	BOSE AMP. ON SIGNAL
32	R	SOUND SIGNAL FRONT DOOR SPEAKER RH -

OPTION HARNESS (DISPLAY AUDIO WITH BOSE SYSTEM)

Connector No.	B138
Connector Name	BOSE AMP.
Connector Type	SHB08FB
Connector Color	Black

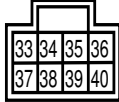

Terminal No.	Color Of Wire	Signal Name [Specification]
33	R	SOUND SIGNAL WOOFER 2 -
34	BR	SOUND SIGNAL FRONT DOOR SPEAKER LH +
35	Y	SOUND SIGNAL WOOFER 1 +
36	L	BATTERY POWER SUPPLY
37	G	SOUND SIGNAL WOOFER 2 +
38	P	SOUND SIGNAL FRONT DOOR SPEAKER LH -
39	BR	SOUND SIGNAL WOOFER 1 -
40	B	GROUND

Connector No.	B148
Connector Name	WOOFER
Connector Type	RS04FGY-PR
Connector Color	Gray

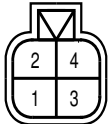

Terminal No.	Color Of Wire	Signal Name [Specification]
1	BR	-
2	Y	-
3	R	-
4	G	-

Connector No.	D1
Connector Name	WIRE TO WIRE
Connector Type	TH24FW-NH
Connector Color	White

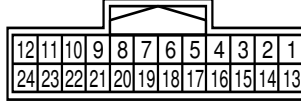

Terminal No.	Color Of Wire	Signal Name [Specification]
1	B	TO MAIN HARNESS [Color of wire varies depending on production]
1	LA/B	TO MAIN HARNESS [Color of wire varies depending on production]
2	B	TO MAIN HARNESS [Color of wire varies depending on production]
2	LA/B	TO MAIN HARNESS [Color of wire varies depending on production]
3	W	TO MAIN HARNESS
4	V	TO MAIN HARNESS
5	SB	TO MAIN HARNESS
6	LG	TO MAIN HARNESS
7	GR	TO MAIN HARNESS
8	G	TO MAIN HARNESS
9	Y	TO MAIN HARNESS
10	B	TO MAIN HARNESS
11	R	TO MAIN HARNESS
13	LA/W	TO MAIN HARNESS [Color of wire varies depending on production]
13	W	TO MAIN HARNESS [Color of wire varies depending on production]
14	LA/Y	TO MAIN HARNESS [Color of wire varies depending on production]
14	Y	TO MAIN HARNESS [Color of wire varies depending on production]
15	LA/LG	TO MAIN HARNESS [Color of wire varies depending on production]
15	LG	TO MAIN HARNESS [Color of wire varies depending on production]
16	LA/V	TO MAIN HARNESS [Color of wire varies depending on production]
16	V	TO MAIN HARNESS [Color of wire varies depending on production]
17	L	TO MAIN HARNESS [Color of wire varies depending on production]
17	LA/L	TO MAIN HARNESS [Color of wire varies depending on production]
18	BG	TO MAIN HARNESS [Color of wire varies depending on production]
18	LA/BG	TO MAIN HARNESS [Color of wire varies depending on production]
19	LA/R	TO MAIN HARNESS [Color of wire varies depending on production]
19	R	TO MAIN HARNESS [Color of wire varies depending on production]
22	G	TO MAIN HARNESS [Color of wire varies depending on production]
22	LA/G	TO MAIN HARNESS [Color of wire varies depending on production]
23	L	TO MAIN HARNESS
24	BG	TO MAIN HARNESS

Connector No.	D2
Connector Name	WIRE TO WIRE
Connector Type	NS16FW-CS
Connector Color	White

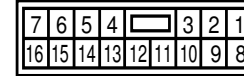

Terminal No.	Color Of Wire	Signal Name [Specification]
1	LA/V	TO MAIN HARNESS [Color of wire varies depending on production]
1	V	TO MAIN HARNESS [Color of wire varies depending on production]
2	R	TO MAIN HARNESS
3	G	TO MAIN HARNESS [Color of wire varies depending on production]
3	LA/G	TO MAIN HARNESS [Color of wire varies depending on production]
4	B	TO MAIN HARNESS
6	L	TO MAIN HARNESS [With 8-speakers]
6	LA/L	TO MAIN HARNESS [With 4-speakers or 6-speakers]
7	BR	TO MAIN HARNESS [With 8-speakers]
7	LA/BR	TO MAIN HARNESS [With 4-speakers or 6-speakers]
8	SB	TO MAIN HARNESS
9	GR	TO MAIN HARNESS [Color of wire varies depending on production]
9	LA/GR	TO MAIN HARNESS [Color of wire varies depending on production]
10	LA/SB	TO MAIN HARNESS [Color of wire varies depending on production]
10	SB	TO MAIN HARNESS [Color of wire varies depending on production]
11	P	TO MAIN HARNESS
12	LG	TO MAIN HARNESS
13	LA/Y	TO MAIN HARNESS [Color of wire varies depending on production]
13	Y	TO MAIN HARNESS [Color of wire varies depending on production]
14	LA/W	TO MAIN HARNESS [Color of wire varies depending on production]
14	W	TO MAIN HARNESS [Color of wire varies depending on production]
15	LA/R	TO MAIN HARNESS [Color of wire varies depending on production]
15	R	TO MAIN HARNESS [Color of wire varies depending on production]
16	B	TO MAIN HARNESS

Connector No.	D3
Connector Name	DOOR MIRROR (DRIVER SIDE)
Connector Type	TH16MW-NH
Connector Color	White

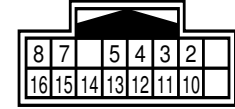

Terminal No.	Color Of Wire	Signal Name [Specification]
2	LG	-
3	LA/P	- [Color of wire varies depending on production]
3	P	- [Color of wire varies depending on production]
4	BR	- [Color of wire varies depending on production]
4	LA/BR	- [Color of wire varies depending on production]
5	LA/W	- [Color of wire varies depending on production]
5	W	- [Color of wire varies depending on production]
7	GR	-
8	G	-
10	B	-
11	LA/SB	- [Color of wire varies depending on production]
11	SB	- [Color of wire varies depending on production]
12	GR	- [Color of wire varies depending on production]
12	LA/GR	- [Color of wire varies depending on production]
13	G	- [Color of wire varies depending on production]
13	LA/G	- [Color of wire varies depending on production]
14	B	- [Color of wire varies depending on production]
14	LA/B	- [Color of wire varies depending on production]
15	B	-
16	Y	-

OPTION HARNESS (DISPLAY AUDIO WITH BOSE SYSTEM)

Connector No.	D19
Connector Name	FRONT DOOR SPEAKER LH
Connector Type	NS02FBR-CS
Connector Color	Brown



Terminal No.	Color Of Wire	Signal Name [Specification]
1	L	-
2	BR	-

Connector No.	D38
Connector Name	FRONT DOOR SPEAKER RH
Connector Type	NS02FBR-CS
Connector Color	Brown



Terminal No.	Color Of Wire	Signal Name [Specification]
1	G	-
2	R	-

Connector No.	D41
Connector Name	WIRE TO WIRE
Connector Type	TH24FW-NH
Connector Color	White

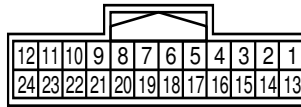

Terminal No.	Color Of Wire	Signal Name [Specification]
1	B	TO MAIN HARNESS
3	B	TO MAIN HARNESS
4	P	TO MAIN HARNESS
5	R	TO MAIN HARNESS
6	SB	TO MAIN HARNESS
7	L	TO MAIN HARNESS
8	V	TO MAIN HARNESS
9	Y	TO MAIN HARNESS
10	B	TO MAIN HARNESS
11	G	TO MAIN HARNESS
13	LA/Y	TO MAIN HARNESS [Color of wire varies depending on production]
13	Y	TO MAIN HARNESS [Color of wire varies depending on production]
14	LA/R	TO MAIN HARNESS [Color of wire varies depending on production]
14	R	TO MAIN HARNESS [Color of wire varies depending on production]
15	LA/V	TO MAIN HARNESS [Color of wire varies depending on production]
15	V	TO MAIN HARNESS [Color of wire varies depending on production]
16	L	TO MAIN HARNESS [Color of wire varies depending on production]
16	LA/L	TO MAIN HARNESS [Color of wire varies depending on production]
17	BG	TO MAIN HARNESS [Color of wire varies depending on production]
17	LA/BG	TO MAIN HARNESS [Color of wire varies depending on production]
18	GR	TO MAIN HARNESS
21	G	TO MAIN HARNESS [Color of wire varies depending on production]
21	LA/G	TO MAIN HARNESS [Color of wire varies depending on production]

Connector No.	D42
Connector Name	WIRE TO WIRE
Connector Type	NS16FW-CS
Connector Color	White

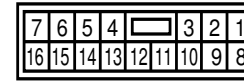

Terminal No.	Color Of Wire	Signal Name [Specification]
1	B	TO MAIN HARNESS [Color of wire varies depending on production]
1	LA/B	TO MAIN HARNESS [Color of wire varies depending on production]
2	B	TO MAIN HARNESS
8	GR	TO MAIN HARNESS [Color of wire varies depending on production]
8	LA/GR	TO MAIN HARNESS [Color of wire varies depending on production]
9	LA/Y	TO MAIN HARNESS [Color of wire varies depending on production]
9	Y	TO MAIN HARNESS [Color of wire varies depending on production]
10	BR	TO MAIN HARNESS [Color of wire varies depending on production]
10	LA/BR	TO MAIN HARNESS [Color of wire varies depending on production]
11	L	TO MAIN HARNESS [Color of wire varies depending on production]
11	LA/L	TO MAIN HARNESS [Color of wire varies depending on production]
12	LA/V	TO MAIN HARNESS [Color of wire varies depending on production]
12	V	TO MAIN HARNESS [Color of wire varies depending on production]
13	LA/R	TO MAIN HARNESS [With 4-speakers or 6-speakers]
13	R	TO MAIN HARNESS [With 8-speakers]
14	G	TO MAIN HARNESS [With 8-speakers]
14	LA/G	TO MAIN HARNESS [With 4-speakers or 6-speakers]

Connector No.	D43
Connector Name	DOOR MIRROR (PASSENGER SIDE)
Connector Type	TH16MW-NH
Connector Color	White

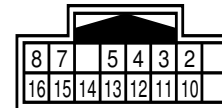

Terminal No.	Color Of Wire	Signal Name [Specification]
2	GR	-
3	L	- [Color of wire varies depending on production]
3	LA/L	- [Color of wire varies depending on production]
4	LA/R	- [Color of wire varies depending on production]
4	R	- [Color of wire varies depending on production]
5	LA/Y	- [Color of wire varies depending on production]
5	Y	- [Color of wire varies depending on production]
7	L	-
8	V	-
10	B	-
11	BG	- [Color of wire varies depending on production]
11	LA/BG	- [Color of wire varies depending on production]
12	LA/V	- [Color of wire varies depending on production]
12	V	- [Color of wire varies depending on production]
13	G	- [Color of wire varies depending on production]
13	LA/G	- [Color of wire varies depending on production]
14	B	- [Color of wire varies depending on production]
14	LA/B	- [Color of wire varies depending on production]
15	B	-
16	Y	-

Connector No.	D84
Connector Name	REAR DOOR SPEAKER LH
Connector Type	NS02FW-CS
Connector Color	White



Terminal No.	Color Of Wire	Signal Name [Specification]
1	L	- [With 8-speakers]
1	LA/L	- [With 4-speakers or 6-speakers]
2	LA/R	- [With 4-speakers or 6-speakers]
2	R	- [With 8-speakers]

OPTION HARNESS (DISPLAY AUDIO WITH BOSE SYSTEM)

Connector No.	D91
Connector Name	WIRE TO WIRE
Connector Type	NS12FW-CS
Connector Color	White

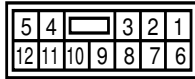

Terminal No.	Color Of Wire	Signal Name [Specification]
1	LA/Y	TO BODY HARNESS [Color of wire varies depending on production]
1	Y	TO BODY HARNESS [Color of wire varies depending on production]
2	BR	TO BODY HARNESS [Color of wire varies depending on production]
2	LA/BR	TO BODY HARNESS [Color of wire varies depending on production]
3	GR	TO BODY HARNESS [Color of wire varies depending on production]
3	LA/GR	TO BODY HARNESS [Color of wire varies depending on production]
4	LA/V	TO BODY HARNESS [With 4-speakers or 6-speakers]
4	V	TO BODY HARNESS [With 8-speakers]
5	LA/Y	TO BODY HARNESS [With 4-speakers or 6-speakers]
5	Y	TO BODY HARNESS [With 8-speakers]
6	LA/W	TO BODY HARNESS [Color of wire varies depending on production]
6	W	TO BODY HARNESS [Color of wire varies depending on production]
7	L	TO BODY HARNESS [Color of wire varies depending on production]
7	LA/L	TO BODY HARNESS [Color of wire varies depending on production]

Connector No.	D104
Connector Name	REAR DOOR SPEAKER RH
Connector Type	NS02FW-CS
Connector Color	White



Terminal No.	Color Of Wire	Signal Name [Specification]
1	LA/V	- [With 4-speakers or 6-speakers]
1	V	- [With 8-speakers]
2	LA/Y	- [With 4-speakers or 6-speakers]
2	Y	- [With 8-speakers]

Connector No.	D111
Connector Name	WIRE TO WIRE
Connector Type	NS12FW-CS
Connector Color	White

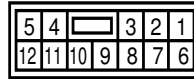

Terminal No.	Color Of Wire	Signal Name [Specification]
1	LA/Y	TO BODY HARNESS [Color of wire varies depending on production]
1	Y	TO BODY HARNESS [Color of wire varies depending on production]
2	BR	TO BODY HARNESS [Color of wire varies depending on production]
2	LA/BR	TO BODY HARNESS [Color of wire varies depending on production]
3	GR	TO BODY HARNESS [Color of wire varies depending on production]
3	LA/GR	TO BODY HARNESS [Color of wire varies depending on production]
6	LA/V	TO BODY HARNESS [Color of wire varies depending on production]
6	V	TO BODY HARNESS [Color of wire varies depending on production]
7	G	TO BODY HARNESS [Color of wire varies depending on production]
7	LA/G	TO BODY HARNESS [Color of wire varies depending on production]
8	LA/R	TO BODY HARNESS [With 4-speakers or 6-speakers]
8	R	TO BODY HARNESS [With 8-speakers]
9	L	TO BODY HARNESS [With 8-speakers]
9	LA/L	TO BODY HARNESS [With 4-speakers or 6-speakers]

Connector No.	D160
Connector Name	WIRE TO WIRE
Connector Type	TH32FW-NH
Connector Color	White

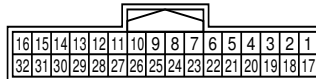

Terminal No.	Color Of Wire	Signal Name [Specification]
5	R	TO BODY HARNESS
6	B	TO BODY HARNESS
7	W	TO BODY HARNESS
8	V	TO BODY HARNESS

13	G	TO BODY HARNESS
14	GR	TO BODY HARNESS [Color of wire varies depending on production]
14	LA/GR	TO BODY HARNESS [Color of wire varies depending on production]
15	LA/W	TO BODY HARNESS [Color of wire varies depending on production]
15	W	TO BODY HARNESS [Color of wire varies depending on production]
16	LA/LG	TO BODY HARNESS [Color of wire varies depending on production]
16	LG	TO BODY HARNESS [Color of wire varies depending on production]
17	Y	TO BODY HARNESS
18	LA/R	TO BODY HARNESS [Color of wire varies depending on production]
18	R	TO BODY HARNESS [Color of wire varies depending on production]
19	W	TO BODY HARNESS
21	G	TO BODY HARNESS
22	LA/Y	TO BODY HARNESS [Color of wire varies depending on production]
22	Y	TO BODY HARNESS [Color of wire varies depending on production]
23	P	TO BODY HARNESS
24	BR	TO BODY HARNESS
29	V	TO BODY HARNESS
30	G	TO BODY HARNESS
31	BG	TO BODY HARNESS
32	LG	TO BODY HARNESS

Connector No.	D171
Connector Name	REAR VIEW CAMERA
Connector Type	RH06FB-1V
Connector Color	Black



Terminal No.	Color Of Wire	Signal Name [Specification]
1	B	GND
2	R	CAMERA_ON
4	W	CAMERA_+
5	V	CAMERA_-

Connector No.	D176
Connector Name	REAR CAMERA
Connector Type	RH06FB-1V
Connector Color	Black



Terminal No.	Color Of Wire	Signal Name [Specification]
1	B	GND
2	R	VCC
4	W	VIDEO+
5	V	VIDEO-

Connector No.	E10
Connector Name	IPDM E/R (INTELLIGENT POWER DISTRIBUTION MODULE ENGINE ROOM)
Connector Type	NS16FGY-CS
Connector Color	Gray

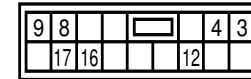

Terminal No.	Color Of Wire	Signal Name [Specification]
3	P	-
4	Y	-
8	BG	-
9	L	-
12	B	-
16	G	-
17	W	-

OPTION HARNESS (DISPLAY AUDIO WITH BOSE SYSTEM)

Connector No.	E77
Connector Name	WIRE TO WIRE
Connector Type	TH16MW-NH
Connector Color	White

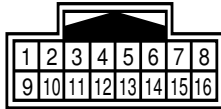

Terminal No.	Color Of Wire	Signal Name [Specification]
1	V	TO ENGINE ROOM HARNESS
2	L	TO ENGINE ROOM HARNESS
3	SB	TO ENGINE ROOM HARNESS
4	P	TO ENGINE ROOM HARNESS
5	G	TO ENGINE ROOM HARNESS
8	GR	TO ENGINE ROOM HARNESS
9	SHIELD	TO ENGINE ROOM HARNESS
10	LG	TO ENGINE ROOM HARNESS
11	V	TO ENGINE ROOM HARNESS
12	W	TO ENGINE ROOM HARNESS
13	LG	TO ENGINE ROOM HARNESS
15	Y	TO ENGINE ROOM HARNESS
16	GR	TO ENGINE ROOM HARNESS

Connector No.	E101
Connector Name	WIRE TO WIRE
Connector Type	TH80FDGY-CS16-TM4
Connector Color	Dark Gray

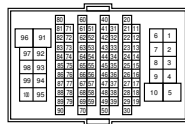

Terminal No.	Color Of Wire	Signal Name [Specification]
1	G	TO BODY HARNESS
2	W	TO BODY HARNESS
4	LG	TO BODY HARNESS
6	BR	TO BODY HARNESS
8	BR	TO BODY HARNESS

11	SB	TO BODY HARNESS
12	V	TO BODY HARNESS
13	P	TO BODY HARNESS
14	W	TO BODY HARNESS
15	G	TO BODY HARNESS
16	LG	TO BODY HARNESS
17	Y	TO BODY HARNESS
20	G	TO BODY HARNESS
21	BR	TO BODY HARNESS
22	LG	TO BODY HARNESS
23	Y	TO BODY HARNESS
24	SB	TO BODY HARNESS
25	G	TO BODY HARNESS
26	B	TO BODY HARNESS
27	L	TO BODY HARNESS
100	SB	TO BODY HARNESS

Connector No.	E105
Connector Name	WIRE TO WIRE
Connector Type	TH80FW-CS16-TM4
Connector Color	White

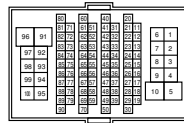

Terminal No.	Color Of Wire	Signal Name [Specification]
2	W	TO MAIN HARNESS
3	GR	TO MAIN HARNESS [Color of wire varies depending on production]
3	R	TO MAIN HARNESS [Color of wire varies depending on production]
4	P	TO MAIN HARNESS
5	V	TO MAIN HARNESS
8	L	TO MAIN HARNESS
9	LG	TO MAIN HARNESS
10	W	TO MAIN HARNESS
20	W	TO MAIN HARNESS
21	B	TO MAIN HARNESS
22	SHIELD	TO MAIN HARNESS
31	Y	TO MAIN HARNESS
33	P	TO MAIN HARNESS
34	Y	TO MAIN HARNESS
35	BG	TO MAIN HARNESS
36	LG	TO MAIN HARNESS
37	V	TO MAIN HARNESS

40	L	TO MAIN HARNESS
41	P	TO MAIN HARNESS
42	L	TO MAIN HARNESS
43	B	TO MAIN HARNESS
44	G	TO MAIN HARNESS
45	BG	TO MAIN HARNESS
46	W	TO MAIN HARNESS
51	P	TO MAIN HARNESS
52	L	TO MAIN HARNESS
53	W	TO MAIN HARNESS
54	Y	TO MAIN HARNESS
55	BR	TO MAIN HARNESS
56	P	TO MAIN HARNESS
57	B	TO MAIN HARNESS
58	BR	TO MAIN HARNESS
59	Y	TO MAIN HARNESS
60	G	TO MAIN HARNESS
63	BR	TO MAIN HARNESS
64	GR	TO MAIN HARNESS
65	LG	TO MAIN HARNESS
66	BG	TO MAIN HARNESS
67	R	TO MAIN HARNESS
68	V	TO MAIN HARNESS
69	P	TO MAIN HARNESS
70	L	TO MAIN HARNESS
71	V	TO MAIN HARNESS
72	L	TO MAIN HARNESS
73	R	TO MAIN HARNESS
74	G	TO MAIN HARNESS
76	L	TO MAIN HARNESS
77	V	TO MAIN HARNESS
78	LG	TO MAIN HARNESS
79	SHIELD	TO MAIN HARNESS
80	GR	TO MAIN HARNESS
81	BG	TO MAIN HARNESS
82	W	TO MAIN HARNESS
83	SB	TO MAIN HARNESS
84	L	TO MAIN HARNESS
85	P	TO MAIN HARNESS
86	Y	TO MAIN HARNESS
88	BG	TO MAIN HARNESS
89	V	TO MAIN HARNESS
90	BR	TO MAIN HARNESS [Color of wire varies depending on production]
90	LG	TO MAIN HARNESS [Color of wire varies depending on production]
91	R	TO MAIN HARNESS
93	W	TO MAIN HARNESS
95	BR	TO MAIN HARNESS
96	GR	TO MAIN HARNESS
97	BG	TO MAIN HARNESS [Color of wire varies depending on production]
97	R	TO MAIN HARNESS [Color of wire varies depending on production]

98	V	TO MAIN HARNESS
99	Y	TO MAIN HARNESS
100	LG	TO MAIN HARNESS

Connector No.	E146
Connector Name	WIRE TO WIRE
Connector Type	TH16FW-NH
Connector Color	White

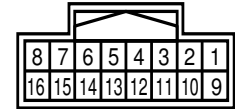

Terminal No.	Color Of Wire	Signal Name [Specification]
1	V	TO ENGINE ROOM HARNESS
2	L	TO ENGINE ROOM HARNESS
3	SB	TO ENGINE ROOM HARNESS
4	P	TO ENGINE ROOM HARNESS
5	G	TO ENGINE ROOM HARNESS
8	GR	TO ENGINE ROOM HARNESS
9	SHIELD	TO ENGINE ROOM HARNESS
10	LG	TO ENGINE ROOM HARNESS
11	V	TO ENGINE ROOM HARNESS
12	W	TO ENGINE ROOM HARNESS
13	LG	TO ENGINE ROOM HARNESS
15	V	TO ENGINE ROOM HARNESS
16	GR	TO ENGINE ROOM HARNESS

Connector No.	E180
Connector Name	FRONT CAMERA
Connector Type	RH04FB
Connector Color	Black

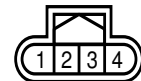

OPTION HARNESS (DISPLAY AUDIO WITH BOSE SYSTEM)

Terminal No.	Color Of Wire	Signal Name [Specification]
1	L	-
2	V	-
3	LG	-
4	SHIELD	-

Connector No.	M3
Connector Name	FUSE BLOCK (J/B)
Connector Type	NS16FW-CS
Connector Color	White

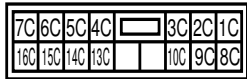

Terminal No.	Color Of Wire	Signal Name [Specification]
10C	LG	-
13C	LA/G	-
14C	LG	-
15C	L	-
16C	LA/W	-
1C	R	-
2C	G	-
3C	LA/Y	-
4C	LG	-
5C	GR	-
6C	LA/R	-
7C	Y	-
8C	BR	- [Color of wire varies depending on production]
8C	LA/BR	- [Color of wire varies depending on production]
9C	L	-

Connector No.	M11
Connector Name	WIRE TO WIRE
Connector Type	TH80FW-CS16-TM4
Connector Color	White

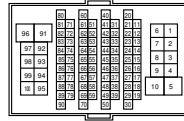

Terminal No.	Color Of Wire	Signal Name [Specification]
1	V	TO BODY HARNESS
2	LA/Y	TO BODY HARNESS
3	BR	TO BODY HARNESS
4	LA/R	TO BODY HARNESS
5	L	TO BODY HARNESS
6	GR	TO BODY HARNESS
7	LA/LG	TO BODY HARNESS
8	L	TO BODY HARNESS
9	LA/SB	TO BODY HARNESS
22	LA/V	TO BODY HARNESS
23	LA/Y	TO BODY HARNESS
31	BR	TO BODY HARNESS
32	R	TO BODY HARNESS
40	L	TO BODY HARNESS
41	B	TO BODY HARNESS
42	G	TO BODY HARNESS
51	R	TO BODY HARNESS
52	W	TO BODY HARNESS
53	SHIELD	TO BODY HARNESS
54	Y	TO BODY HARNESS
55	L	TO BODY HARNESS
56	SHIELD	TO BODY HARNESS
58	GR	TO BODY HARNESS
59	R	TO BODY HARNESS
60	R	TO BODY HARNESS
61	G	TO BODY HARNESS
62	SHIELD	TO BODY HARNESS
63	V	TO BODY HARNESS
64	LG	TO BODY HARNESS
65	SHIELD	TO BODY HARNESS
66	BR	TO BODY HARNESS
68	W	TO BODY HARNESS
69	G	TO BODY HARNESS
71	Y	TO BODY HARNESS
72	Y	TO BODY HARNESS

73	R	TO BODY HARNESS
74	R	TO BODY HARNESS
75	Y	TO BODY HARNESS
76	BR	TO BODY HARNESS
77	BR	TO BODY HARNESS
78	LA/L	TO BODY HARNESS
80	G	TO BODY HARNESS
81	L	TO BODY HARNESS
82	GR	TO BODY HARNESS
83	L	TO BODY HARNESS
84	L	TO BODY HARNESS
85	GR	TO BODY HARNESS
86	W	TO BODY HARNESS
88	LA/B	TO BODY HARNESS
90	G	TO BODY HARNESS
91	BR	TO BODY HARNESS
92	LA/W	TO BODY HARNESS
93	LA/Y	TO BODY HARNESS
95	SB	TO BODY HARNESS
96	LG	TO BODY HARNESS
97	BG	TO BODY HARNESS
98	Y	TO BODY HARNESS
99	W	TO BODY HARNESS
100	LA/R	TO BODY HARNESS

Connector No.	M13
Connector Name	WIRE TO WIRE
Connector Type	TH32FW-NH
Connector Color	White

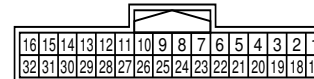

Terminal No.	Color Of Wire	Signal Name [Specification]
3	SB	TO BODY HARNESS
4	BR	TO BODY HARNESS
5	L	TO BODY HARNESS
6	Y	TO BODY HARNESS
7	LG	TO BODY HARNESS
8	BG	TO BODY HARNESS
9	G	TO BODY HARNESS
10	Y	TO BODY HARNESS
11	R	TO BODY HARNESS

17	LA/BR	TO BODY HARNESS
18	LA/L	TO BODY HARNESS
19	Y	TO BODY HARNESS
20	L	TO BODY HARNESS
24	P	TO BODY HARNESS
25	L	TO BODY HARNESS
26	BR	TO BODY HARNESS
29	SHIELD	TO BODY HARNESS
30	W	TO BODY HARNESS
31	B	TO BODY HARNESS
32	R	TO BODY HARNESS

Connector No.	M18
Connector Name	WIRE TO WIRE
Connector Type	TH24MW-NH
Connector Color	White

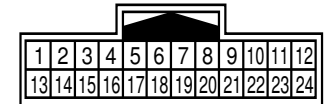

Terminal No.	Color Of Wire	Signal Name [Specification]
1	B	TO DOOR HARNESS
2	B	TO DOOR HARNESS
3	Y	TO DOOR HARNESS
4	V	TO DOOR HARNESS
5	BR	TO DOOR HARNESS
6	LG	TO DOOR HARNESS
7	L	TO DOOR HARNESS
8	Y	TO DOOR HARNESS
9	G	TO DOOR HARNESS
10	SHIELD	TO DOOR HARNESS
11	R	TO DOOR HARNESS
13	GR	TO DOOR HARNESS
14	LA/SB	TO DOOR HARNESS
15	LA/GR	TO DOOR HARNESS
16	LA/V	TO DOOR HARNESS
17	LA/L	TO DOOR HARNESS
18	LA/BG	TO DOOR HARNESS
19	LA/R	TO DOOR HARNESS
22	LA/G	TO DOOR HARNESS
23	BG	TO DOOR HARNESS
24	SB	TO DOOR HARNESS

OPTION HARNESS (DISPLAY AUDIO WITH BOSE SYSTEM)

Connector No.	M19
Connector Name	WIRE TO WIRE
Connector Type	NS16MW-CS
Connector Color	White

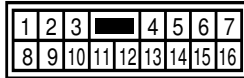

Terminal No.	Color Of Wire	Signal Name [Specification]
1	V	TO DOOR HARNESS
2	LA/R	TO DOOR HARNESS
3	G	TO DOOR HARNESS
4	B	TO DOOR HARNESS
6	L	TO DOOR HARNESS [With 8-speakers]
6	LA/Y	TO DOOR HARNESS [With 4-speakers]
6	Y	TO DOOR HARNESS [With 6-speakers]
7	BR	TO DOOR HARNESS [With 8-speakers]
7	LA/R	TO DOOR HARNESS [With 4-speakers]
7	R	TO DOOR HARNESS [With 6-speakers]
8	L	TO DOOR HARNESS
9	BR	TO DOOR HARNESS
10	GR	TO DOOR HARNESS
11	Y	TO DOOR HARNESS
12	BG	TO DOOR HARNESS
13	LA/G	TO DOOR HARNESS
14	LA/R	TO DOOR HARNESS
15	P	TO DOOR HARNESS
16	B	TO DOOR HARNESS

Connector No.	M22
Connector Name	TWEETER RH
Connector Type	TH02FW
Connector Color	White



Terminal No.	Color Of Wire	Signal Name [Specification]
1	G	-
2	R	-

Connector No.	M24
Connector Name	AROUND VIEW MONITOR CONTROL UNIT
Connector Type	TH40FW-NH
Connector Color	White



Terminal No.	Color Of Wire	Signal Name [Specification]
1	SHIELD	VIDEO OUTPUT(-)OUTSIDE
2	R	VIDEO OUTPUT(+)OUTSIDE
3	SHIELD	CAMERA IMAGE SIGNAL GROUND
4	G	CAMERA IMAGE SIGNAL
5	V	FRONT CAMERA GROUND
6	L	FRONT CAMERA POWER SUPPLY
7	SHIELD	FRONT CAMERA IMAGE SIGNAL GROUND
8	LG	FRONT CAMERA IMAGE SIGNAL
9	L	PASSENGER SIDE CAMERA GROUND
10	B	PASSENGER SIDE CAMERA POWER SUPPLY
11	SHIELD	PASSENGER SIDE CAMERA IMAGE SIGNAL GROUND
12	Y	PASSENGER SIDE CAMERA IMAGE SIGNAL
13	Y	DRIVER SIDE CAMERA GROUND
14	L	DRIVER SIDE CAMERA POWER SUPPLY
15	SHIELD	DRIVER SIDE CAMERA IMAGE SIGNAL GROUND
16	G	DRIVER SIDE CAMERA IMAGE SIGNAL

17	B	REAR CAMERA GROUND
18	R	REAR CAMERA POWER SUPPLY
19	SHIELD	REAR CAMERA IMAGE SIGNAL GROUND
20	W	REAR CAMERA IMAGE SIGNAL
24	Y	ITS CAN-L
25	G	CAMERA SWITCH SIGNAL [Color of wire varies depending on production]
25	W	CAMERA SWITCH SIGNAL [Color of wire varies depending on production]
26	L	ITS CAN-H
27	BG	AROUND VIEW MONITOR RECOGNITION SIGNAL
28	LG	SERIAL GND
29	G	From PC to CU
30	P	From CU to PC
34	BG	CAMERA OFF SIGNAL
35	V	VIEW CHANGE SIGNAL
39	B	GROUND
40	SB	IGNITION SIGNAL

Connector No.	M33
Connector Name	COMBINATION SWITCH (SPIRAL CABLE)
Connector Type	TH12FW-NH
Connector Color	White

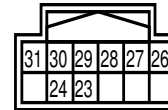

Terminal No.	Color Of Wire	Signal Name [Specification]
23	L	-
24	GR	-
26	BG	-
27	LA/R	-
28	LA/BR	-
29	Y	-
30	B	COMBINATION SWITCH (SPIRAL CABLE) GROUND
31	R	-

Connector No.	M34
Connector Name	COMBINATION METER
Connector Type	TH40FW-NH
Connector Color	White

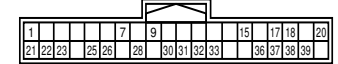

Terminal No.	Color Of Wire	Signal Name [Specification]
1	B	GROUND
7	BG	SECURITY SIGNAL
9	GR	ECO MODE SWITCH SIGNAL
15	L	AMBIENT SENSOR SIGNAL
17	BG	METER CONTROL SWITCH GROUND
18	SB	TRIP RESET SWITCH SIGNAL
20	Y	AMBIENT SENSOR GROUND
21	L	STEERING SWITCH GROUND
22	Y	STEERING SWITCH SIGNAL A
23	GR	STEERING SWITCH SIGNAL B
25	V	BRAKE FLUID LEVEL SWITCH SIGNAL
26	G	PARKING BRAKE SWITCH SIGNAL
28	Y	SEAT BELT BUCKLE SWITCH SIGNAL (DRIVER SIDE)
30	LG	MANUAL MODE SIGNAL
31	SB	NON-MANUAL MODE SIGNAL
32	BG	MANUAL MODE SHIFT UP SIGNAL
33	BR	MANUAL MODE SHIFT DOWN SIGNAL
36	GR	ILLUMINATION CONTROL SWITCH SIGNAL (+)
37	V	ILLUMINATION CONTROL SWITCH SIGNAL (-)
38	G	VEHICLE SPEED SIGNAL (8-PULSE)
39	LA/W	VEHICLE SPEED SIGNAL (2-PULSE)

OPTION HARNESS (DISPLAY AUDIO WITH BOSE SYSTEM)

Connector No.	M42
Connector Name	COMBINATION METER
Connector Type	TH12FW-NH
Connector Color	White

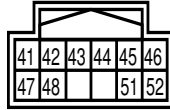

Terminal No.	Color Of Wire	Signal Name [Specification]
41	L	CAN-H
42	R	CAN-L
43	P	ILLUMINATION CONTROL SIGNAL
44	LA/B	FUEL LEVEL SENSOR GROUND
45	LA/G	BATTERY POWER SUPPLY
46	LA/BR	IGNITION SIGNAL [2WD models]
46	V	IGNITION SIGNAL [4WD models]
47	SB	AV COMMUNICATION SIGNAL (H)
48	LG	AV COMMUNICATION SIGNAL (L)
51	LA/L	FUEL LEVEL SENSOR SIGNAL
52	B	GROUND

Connector No.	M60
Connector Name	WIRE TO WIRE
Connector Type	TH24FW-NH
Connector Color	White

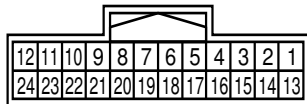

Terminal No.	Color Of Wire	Signal Name [Specification]
1	B	TO ROOF HARNESS
2	W	TO ROOF HARNESS
3	SHIELD	TO ROOF HARNESS
4	R	TO ROOF HARNESS

Connector No.	M77
Connector Name	WIRE TO WIRE
Connector Type	TH80MW-CS16-TM4
Connector Color	White

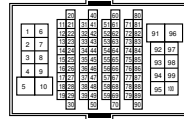

Terminal No.	Color Of Wire	Signal Name [Specification]
2	LA/R	TO ENGINE ROOM HARNESS
3	R	TO ENGINE ROOM HARNESS
4	BR	TO ENGINE ROOM HARNESS
5	V	TO ENGINE ROOM HARNESS
8	G	TO ENGINE ROOM HARNESS
9	Y	TO ENGINE ROOM HARNESS
10	R	TO ENGINE ROOM HARNESS
20	W	TO ENGINE ROOM HARNESS
21	B	TO ENGINE ROOM HARNESS
22	SHIELD	TO ENGINE ROOM HARNESS
31	V	TO ENGINE ROOM HARNESS
33	P	TO ENGINE ROOM HARNESS
34	Y	TO ENGINE ROOM HARNESS
35	BG	TO ENGINE ROOM HARNESS
36	LG	TO ENGINE ROOM HARNESS
37	V	TO ENGINE ROOM HARNESS
40	L	TO ENGINE ROOM HARNESS
41	P	TO ENGINE ROOM HARNESS
42	L	TO ENGINE ROOM HARNESS
43	B	TO ENGINE ROOM HARNESS
44	G	TO ENGINE ROOM HARNESS
45	LA/V	TO ENGINE ROOM HARNESS
46	LA/Y	TO ENGINE ROOM HARNESS
51	GR	TO ENGINE ROOM HARNESS
52	SB	TO ENGINE ROOM HARNESS
53	R	TO ENGINE ROOM HARNESS
54	LA/L	TO ENGINE ROOM HARNESS
55	BR	TO ENGINE ROOM HARNESS
56	SB	TO ENGINE ROOM HARNESS
57	B	TO ENGINE ROOM HARNESS
58	L	TO ENGINE ROOM HARNESS
59	V	TO ENGINE ROOM HARNESS
60	LA/R	TO ENGINE ROOM HARNESS
63	LA/BR	TO ENGINE ROOM HARNESS
64	Y	TO ENGINE ROOM HARNESS

65	GR	TO ENGINE ROOM HARNESS
66	BG	TO ENGINE ROOM HARNESS
67	G	TO ENGINE ROOM HARNESS
68	B	TO ENGINE ROOM HARNESS
69	P	TO ENGINE ROOM HARNESS
70	L	TO ENGINE ROOM HARNESS
71	V	TO ENGINE ROOM HARNESS
72	L	TO ENGINE ROOM HARNESS
73	Y	TO ENGINE ROOM HARNESS
74	G	TO ENGINE ROOM HARNESS
76	L	TO ENGINE ROOM HARNESS
77	V	TO ENGINE ROOM HARNESS
78	LG	TO ENGINE ROOM HARNESS
79	SHIELD	TO ENGINE ROOM HARNESS
80	L	TO ENGINE ROOM HARNESS [With stop/start system]
80	LA/L	TO ENGINE ROOM HARNESS [Without stop/start system]
81	LA/V	TO ENGINE ROOM HARNESS
82	LA/Y	TO ENGINE ROOM HARNESS
83	LG	TO ENGINE ROOM HARNESS
84	SB	TO ENGINE ROOM HARNESS
85	P	TO ENGINE ROOM HARNESS
86	Y	TO ENGINE ROOM HARNESS
88	BG	TO ENGINE ROOM HARNESS
89	V	TO ENGINE ROOM HARNESS
90	BR	TO ENGINE ROOM HARNESS [Color of wire varies depending on production]
90	LG	TO ENGINE ROOM HARNESS [Color of wire varies depending on production]
91	L	TO ENGINE ROOM HARNESS [Color of wire varies depending on production]
91	R	TO ENGINE ROOM HARNESS [Color of wire varies depending on production]
93	W	TO ENGINE ROOM HARNESS
95	BR	TO ENGINE ROOM HARNESS
96	GR	TO ENGINE ROOM HARNESS [Color of wire varies depending on production]
96	LG	TO ENGINE ROOM HARNESS [Color of wire varies depending on production]
97	BR	TO ENGINE ROOM HARNESS
98	V	TO ENGINE ROOM HARNESS
99	R	TO ENGINE ROOM HARNESS
100	LG	TO ENGINE ROOM HARNESS

Connector No.	M80
Connector Name	TWEETER LH
Connector Type	TH02FW
Connector Color	White



Terminal No.	Color Of Wire	Signal Name [Specification]
1	W	-
2	GR	-

Connector No.	M81
Connector Name	WIRE TO WIRE
Connector Type	TH24MW-NH
Connector Color	White

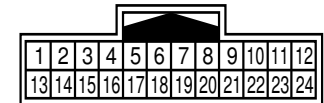

Terminal No.	Color Of Wire	Signal Name [Specification]
1	B	TO DOOR HARNESS
3	B	TO DOOR HARNESS [Color of wire varies depending on production]
3	GR	TO DOOR HARNESS [Color of wire varies depending on production]
4	W	TO DOOR HARNESS
5	P	TO DOOR HARNESS
6	SB	TO DOOR HARNESS
7	B	TO DOOR HARNESS
8	L	TO DOOR HARNESS
9	Y	TO DOOR HARNESS
10	SHIELD	TO DOOR HARNESS
11	G	TO DOOR HARNESS
13	LA/SB	TO DOOR HARNESS
14	LA/GR	TO DOOR HARNESS
15	LA/V	TO DOOR HARNESS
16	LA/L	TO DOOR HARNESS
17	LA/BG	TO DOOR HARNESS

OPTION HARNESS (DISPLAY AUDIO WITH BOSE SYSTEM)

18	GR	TO DOOR HARNESS
21	LA/Y	TO DOOR HARNESS

Connector No.	M82
Connector Name	WIRE TO WIRE
Connector Type	NS16MW-CS
Connector Color	White

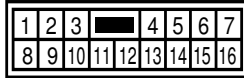

Terminal No.	Color Of Wire	Signal Name [Specification]
1	B	TO DOOR HARNESS
2	B	TO DOOR HARNESS [Color of wire varies depending on production]
2	GR	TO DOOR HARNESS [Color of wire varies depending on production]
8	SB	TO DOOR HARNESS
9	BR	TO DOOR HARNESS
10	GR	TO DOOR HARNESS
11	L	TO DOOR HARNESS
12	Y	TO DOOR HARNESS
13	GR	TO DOOR HARNESS [With 6-speakers]
13	LA/GR	TO DOOR HARNESS [With 4-speakers]
13	LA/R	TO DOOR HARNESS [With 8-speakers]
14	LA/SB	TO DOOR HARNESS [With 8-speakers]
14	LA/W	TO DOOR HARNESS [With 4-speakers]
14	W	TO DOOR HARNESS [With 6-speakers]

Connector No.	M137
Connector Name	ELECTRIC PARKING BRAKE CONTROL MODULE
Connector Type	AAA22FB-AJY8
Connector Color	Black

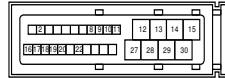

Terminal No.	Color Of Wire	Signal Name [Specification]
2	V	PARKING BRAKE SIGNAL [Color of wire varies depending on production]
2	W	PARKING BRAKE SIGNAL [Color of wire varies depending on production]
8	SB	PARKING BRAKE SW INDICATOR LAMP
9	BR	PARKING BRAKE SW RELEASE (NOR-OP)
10	BG	PARKING BRAKE SW RELEASE (NOR-CL)
11	V	PARKING BRAKE SW POWER SUPPLY (APPLY)
12	GR	MOTOR RH (+)
13	R	MOTOR POWER SUPPLY (RH)
14	W	MOTOR LH (+)
15	V	MOTOR POWER SUPPLY (LH)
16	L	CAN-H
17	P	CAN-L
18	BG	PARKING BRAKE SW APPLY (NOR-OP)
19	G	PARKING BRAKE SW APPLY (NOR-CL)
20	Y	PARKING BRAKE SW POWER SUPPLY (RELEASE)
22	GR	IGNITION POWER SUPPLY
27	G	MOTOR RH (-)
28	B	GROUND (MOTOR RH)
29	BR	MOTOR LH (-)
30	B	GROUND (MOTOR LH)

Connector No.	M189
Connector Name	JOINT CONNECTOR-M13
Connector Type	SAC08JW
Connector Color	-

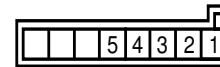

Terminal No.	Color Of Wire	Signal Name [Specification]
1	SHIELD	-
2	B	-
3	SHIELD	-
4	SHIELD	-
5	SHIELD	-

Connector No.	M193
Connector Name	JOINT CONNECTOR-M11
Connector Type	NH20FL-DC
Connector Color	Blue

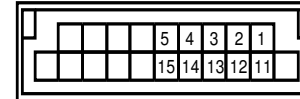

Terminal No.	Color Of Wire	Signal Name [Specification]
1	SB	-
2	LG	- [Color of wire varies depending on production]
2	SB	- [Color of wire varies depending on production]
3	SB	-
4	SB	-
5	SB	-
11	LG	-
12	LG	- [Color of wire varies depending on production]
12	SB	- [Color of wire varies depending on production]
13	LG	-
14	LG	-
15	LG	-

Connector No.	M208
Connector Name	OPTION CONNECTOR (AUDIO UNIT)
Connector Type	NH18FW-CS2
Connector Color	White

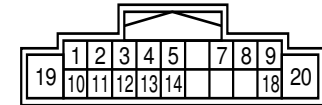

Terminal No.	Color Of Wire	Signal Name [Specification]
1	BR	AMP_ON
2	LA/R	SOUND SIGNAL FRONT LH + [With 8-speakers]
2	LA/Y	SOUND SIGNAL FRONT LH + [With 4-speakers]
2	W	SOUND SIGNAL FRONT LH + [With 6-speakers]
3	LA/G	SOUND SIGNAL FRONT LH - [With 8-speakers]
3	LA/R	SOUND SIGNAL FRONT LH - [With 4-speakers]
3	P	SOUND SIGNAL FRONT LH - [With 6-speakers]
4	LA/GR	SOUND SIGNAL REAR LH + [With 4-speakers or 6-speakers]
4	LA/V	SOUND SIGNAL REAR LH + [With 8-speakers]
5	LA/BR	SOUND SIGNAL REAR LH - [With 4-speakers or 6-speakers]
5	LA/LG	SOUND SIGNAL REAR LH - [With 8-speakers]
7	LG	IGNITION SIGNAL
8	R	ILLUMINATION SIGNAL
9	V	ILLUMINATION SIGNAL
10	B	AMP_GND
11	LA/R	SOUND SIGNAL FRONT RH + [With 8-speakers]
11	LA/W	SOUND SIGNAL FRONT RH + [With 4-speakers]
12	LA/GR	SOUND SIGNAL FRONT RH - [With 4-speakers]
12	LA/W	SOUND SIGNAL FRONT RH - [With 8-speakers]
13	LA/L	SOUND SIGNAL REAR RH + [With 8-speakers]
13	LA/LG	SOUND SIGNAL REAR RH + [With 4-speakers or 6-speakers]
14	LA/Y	SOUND SIGNAL REAR RH -
18	G	VEHICLE SPEED SIGNAL (8-PULSE)
19	L	BATTERY POWER SUPPLY
20	B	GROUND

OPTION HARNESS (DISPLAY AUDIO WITH BOSE SYSTEM)

Connector No.	M209
Connector Name	OPTION CONNECTOR (AUDIO UNIT)
Connector Type	TH40FW-NH
Connector Color	White



Terminal No.	Color Of Wire	Signal Name [Specification]
21	SB	M-CAN_L_TRM
22	LG	M-CAN_H_TRM
23	LG	M-CAN1L
24	SB	M-CAN1H
25	V	PKB_SIGNAL
26	R	HF/VR_MODE_CHANGE
30	BR	REVERSE_SIG
34	W	Camera_SW
35	BG	Camera_OFF
36	B	EQ1
39	V	Camera_Switching_input
40	B	EQ3
41	W	TCU-ACC
42	B	EQ4
43	Y	TCU_GPS_TX
46	W	MIC_SIG+
47	B	MIC_V
48	SHIELD	MIC_GND
57	B	CAMERA_GND
58	R	CAMERA_6.2V
59	G	COMPOSITE+ [With around view monitor]
59	W	COMPOSITE+ [Without around view monitor]
60	SHIELD	COMPOSITE-

Connector No.	M210
Connector Name	OPTION CONNECTOR (TCU)
Connector Type	TH40FB-NH
Connector Color	Black



Terminal No.	Color Of Wire	Signal Name [Specification]
1	L	BATTERY POWER SUPPLY
2	GR	AUTOACC
3	Y	ACC_OUTPUT
6	L	CAN-H
7	P	CAN-L
10	LG	WAKE_UP_IGN
20	Y	TCU_TO_DA_RX
28	B	GROUND
29	B	GROUND
33	BG	SECURITY_INDICATOR
35	V	PARKING BRAKE
39	Y	DR_SEAT_BELT(LH)

Connector No.	M303
Connector Name	COMBINATION SWITCH (SPIRAL CABLE)
Connector Type	TH12FW-NH
Connector Color	White

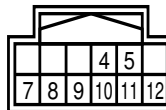

Terminal No.	Color Of Wire	Signal Name [Specification]
4	-	-
5	-	-
7	-	-
8	-	-
9	-	-
10	-	-

11	-	-
12	-	-

Connector No.	M375
Connector Name	WIRE TO WIRE
Connector Type	GT13SC-2_1S-HU
Connector Color	-

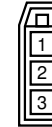

Terminal No.	Color Of Wire	Signal Name [Specification]
1	-	-
2	-	-

Connector No.	M385
Connector Name	WIRE TO WIRE
Connector Type	GT13SCN-2_1PP-HU
Connector Color	-

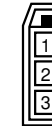

Terminal No.	Color Of Wire	Signal Name [Specification]
1	-	-
2	-	-

Connector No.	M386
Connector Name	ANTENNA BASE
Connector Type	GT13SH-2
Connector Color	Shield



Terminal No.	Color Of Wire	Signal Name [Specification]
1	-	-
2	-	-

Connector No.	M431
Connector Name	USB CONNECTOR
Connector Type	HIROSE_GT17H-4S-HU
Connector Color	-

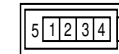

Terminal No.	Color Of Wire	Signal Name [Specification]
1	-	-
2	-	-
3	-	-
4	-	-
5	-	-

OPTION HARNESS (DISPLAY AUDIO WITH BOSE SYSTEM)

Connector No.	M434
Connector Name	OPTION CONNECTOR (AUDIO UNIT)
Connector Type	GT13SH-2
Connector Color	Shield



Terminal No.	Color Of Wire	Signal Name [Specification]
67	-	ANTENNA SIGNAL
68	-	ANTENNA AMP. ON SIGNAL

Connector No.	M435
Connector Name	OPTION CONNECTOR (AUDIO UNIT)
Connector Type	HAA04FL
Connector Color	Blue

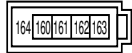

Terminal No.	Color Of Wire	Signal Name [Specification]
160	-	USB GROUND
161	-	V BUS SIGNAL
162	-	USB D- SIGNAL
163	-	USB D+ SIGNAL
164	-	SHIELD

Connector No.	R5
Connector Name	WIRE TO WIRE
Connector Type	TH24MW-NH
Connector Color	White

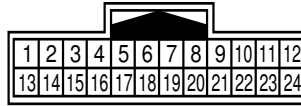

Terminal No.	Color Of Wire	Signal Name [Specification]
1	B	-
2	W	-
3	SHIELD	-
4	-	-

Connector No.	R21
Connector Name	MICROPHONE
Connector Type	A06FW
Connector Color	White

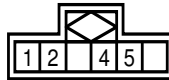

Terminal No.	Color Of Wire	Signal Name [Specification]
1	-	MICROPHONE SIGNAL
2	-	MICROPHONE GROUND
4	-	MICROPHONE VCC
5	-	-